

641 333 238 *** Doska do exikátora				Kat. č. 238
***	Typ	pre D exsik. (mm)	D (mm)	Balenie (ks)
107	238/1	100	90	10
337	238/3b	150	140	10
527	238/5a	200	189	5
827	238/8a	250	241	5
997	238/10a	300	290	5

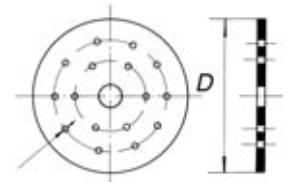

641 333 238 \*\*\*

641 323 227 *** Kadička nízka s výlevkou					Kat. č. 227
***	Typ	V (ml)	D (mm)	H (mm)	Balenie (ks)
107	227/1	275	70	26	3
207	227/2	400	80	99	3
307	227/3	620	90	116	3
407	227/4	860	100	129	2
507	227/5	1070	123	100	3

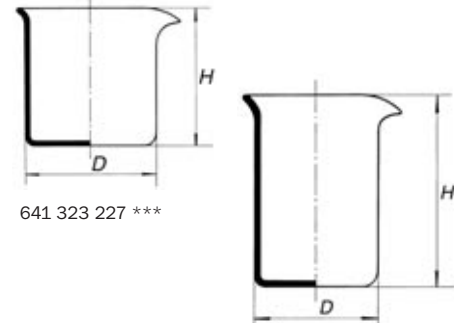

641 323 227 \*\*\*

641 323 226 \*\*\*

641 323 226 *** Kadička vysoká s výlevkou					Kat. č. 226
***	Typ	V (ml)	D (mm)	H (mm)	Balenie (ks)
107	226/1	170	52	90	10
207	226/2	225	57	106	4
307	226/3	450	70	143	4
407	226/4	1100	101	157	2

641 321 100 *** Kelímok spaľovací nízky					Kat. č. 1
***	Typ	V (ml)	D (mm)	H (mm)	Balenie (ks)
307	1/30	5	30	19	10
357	1/35	10	35	22	10
407	1/40	17	40	25	10
457	1/45	21	45	28	10
507	1/50	34	50	32	10
607	1/60	63	60	38	10
707	1/70	91	70	44	10

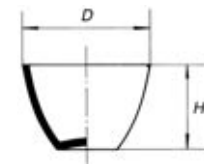

641 321 100 \*\*\*

641 321 200 *** Kelímok spaľovací stredný					Kat. č. 2
***	Typ	V (ml)	D (mm)	H (mm)	Balenie (ks)
357	2/35	12	35	28	10
407	2/40	20	40	32	10
457	2/45	30	45	36	10
507	2/50	45	50	40	10
607	2/60	80	60	48	10
707	2/70	120	70	56	10

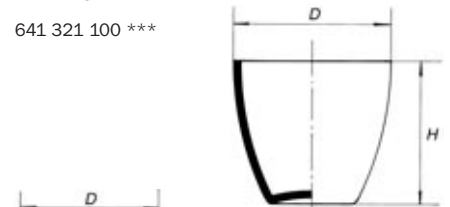

641 321 200 \*\*\*

641 321 300 *** Kelímok spaľovací vysoký					Kat. č. 3
***	Typ	V (ml)	D (mm)	H (mm)	Balenie (ks)
307	3/30	15	30	38	10
357	3/35	26	35	44	10
407	3/40	35	40	50	10
457	3/45	50	45	56	10
507	3/50	72	50	62	10
607	3/60	130	60	75	10

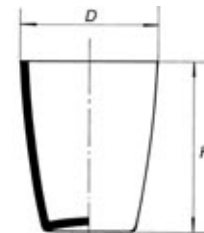

641 321 300 \*\*\*

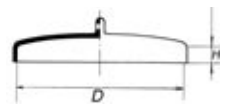

641 321 000 \*\*\*

641 321 000 *** Viečko na kelímok spaľovací					Kat. č. D
***	Typ	D kelímka (mm)	D viečka (mm)	Balenie (ks)	
307	D 30	30	34	10	
357	D 35	35	39	10	
407	D 40	40	44	10	
457	D 45	45	49	10	
507	D 50	50	54	10	
607	D 60	60	64	10	
707	D 70	70	74	10	

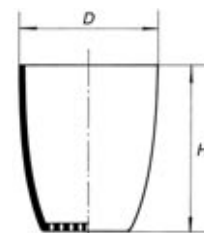

641 321 234 \*\*\*

641 321 234 *** Kelímok Goochov					Kat. č. 234
***	Typ	V (ml)	D (mm)	H (mm)	Balenie (ks)
307	234/3	25	35	43	10
407	234/4	35	39	49	10
507	234/5	120	60	71	10

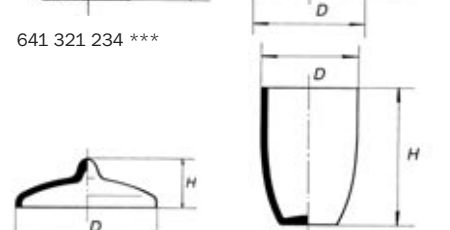

641 321 098 006

641 321 301 *** Kelímok na puchnutie s viečkom					Kat. č. 0301
***	Typ	V (ml)	D (mm)	H (mm)	Balenie (ks)
006	0301	19	43	27	10

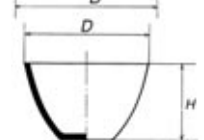

641 321 301 006

641 321 098 *** Kelímok pre stanovenie prchavej kvapaliny s viečkom					Kat. č. 098
***	Typ	V (ml)	D (mm)	H (mm)	Balenie (ks)
006	098	22	32	42	10

## 1.2. Laboratórny porcelán

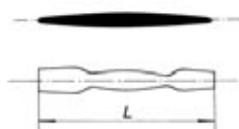

641 334 217 \*\*\*

<b>641 334 217 *** Kopistka dvojitá</b>			<b>Kat. č. 217</b>
***	Typ	L (mm)	Balenie (ks)
107	217/1	104	10
207	217/2	186	10
307	217/3	250	10
407	217/4	298	10

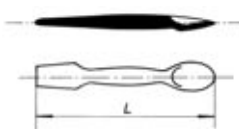

641 334 218 \*\*\*

<b>641 334 218 *** Kopistka s lyžicou</b>			<b>Kat. č. 218</b>
***	Typ	L (mm)	Balenie (ks)
107	218/1	103	10
127	218/1a	148	10
137	218/1b	164	10
207	218/2	187	10
227	218/2a	200	10
307	218/3	250	10



641 151 \*\*\* \*\*

<b>641 151 *** ** Guľa mlecia porcelánová</b>			Balenie (ks)
*** **	Typ	d (mm)	Balenie (ks)
040 010	guľa	40	1
050 010	guľa	50	1

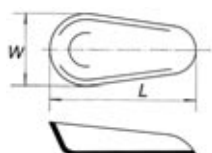

641 329 252 \*\*\*

<b>641 329 252 *** Lodička na váženie</b>				<b>Kat. č. 252</b>
***	Typ	W (mm)	L (mm)	Balenie (ks)
007	252/0	17	37	20
107	252/1	23	53	20
207	252/2	29	64	20

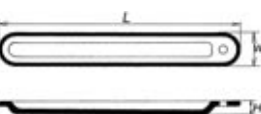

641 312 214 \*\*\*

<b>641 312 214 *** Lodička spaľovacia s uškom</b>					<b>Kat. č. 214</b>
***	Typ	H (mm)	W (mm)	L (mm)	Balenie (ks)
300	214/3	9	14	103	50
800	214/8	8	14	90	50



641 334 219 107

<b>641 334 219 *** Lyžica</b>			<b>Kat. č. 218a</b>
***	Typ	L (mm)	Balenie (ks)
107	218a/1	237	10



641 322 206 \*\*\*

<b>641 322 206 *** Miska odparovacia hlboká</b>						<b>Kat. č. 206</b>
***	Typ	V (ml)	D (mm)	H (mm)	Balenie (ks)	
007	206/0	10	42	19	20	
107	206/1	24	51	24	20	
127	206/1a	36	61	28	20	
207	206/2	72	77	33	10	
227	206/2a	107	81	38	10	
307	206/3	140	94	42	10	
327	206/3a	190	103	45	10	
407	206/4	232	112	47	10	
427	206/4a	390	132	55	10	
507	206/5	500	138	61	10	
607	206/6	590	148	66	10	
627	206/6a	920	170	74	10	
707	206/7	1135	180	84	5	
807	206/8	1500	202	86	5	
997	206/10a	6000	320	140	1	

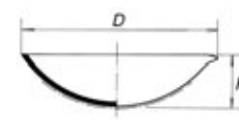

641 322 207 \*\*\*

<b>641 322 207 *** Miska odparovacia polohlboká</b>						<b>Kat. č. 207</b>
***	Typ	V (ml)	D (mm)	H (mm)	Balenie (ks)	
107	207/1	41	72	26	20	
207	207/2	62	83	27	20	
307	207/3	110	96	30	20	
407	207/4	160	110	37	10	
427	207/4a	215	117	41	10	
507	207/5	240	127	42	10	
527	207/5a	325	142	46	10	
607	207/6	420	154	50	10	
707	207/7	558	170	55	5	

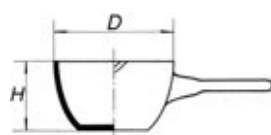

641 322 209 \*\*\*

<b>641 322 209 *** Miska odparovacia s držadlom</b>						<b>Kat. č. 209</b>
***	Typ	V (ml)	D (mm)	H (mm)	Balenie (ks)	
107	209/1	22	45	26	10	
207	209/2	84	67	39	10	
307	209/3	176	85	49	10	
407	209/4	270	101	51	10	
507	209/5	450	120	64	10	
607	209/6	960	150	86	6	

<b>641 322 210 *** Miska odparovacia s odnímateľným držadlom a viečkom Kat. č. 210</b>						
***	Typ	V (ml)	D (mm)	H (mm)	Balenie (ks)	
107	210/1	miska	125	75	40	1
117	210/1V	viečko		87	30	1
207	210/2	miska	200	85	45	1
217	210/2V	viečko		100	34	1

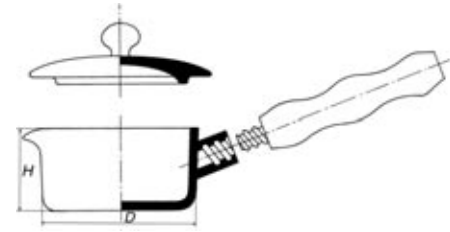

641 322 210 \*\*\*

<b>641 322 274 *** Miska odparovacia s rovným dnom Kat. č. 274</b>					
***	Typ	V (ml)	D (mm)	H (mm)	Balenie (ks)
107	274/1	22	54	22	20
127	274/1a	62	70	30	20
207	274/2	93	86	33	20
307	274/3	154	98	40	10
407	274/4	265	112	50	10
507	274/5	330	126	53	10
607	274/6	450	145	55	10
707	274/7	620	151	63	10
807	274/8	800	169	68	10
907	274/9	1200	195	74	5
997	274/10	3000	254	105	5

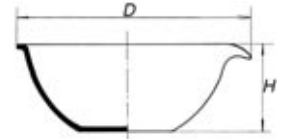

641 322 274 \*\*\*

<b>641 331 211 *** Miska trecia drsná Kat. č. 211a</b>					
***	Typ	V (ml)	D (mm)	H (mm)	Balenie (ks)
006	211a/0 dr.	25	60	32	10
106	211/1 dr.	30	70	37	10
116	211/1/0 dr.	50	81	42	5
126	211/1a dr.	75	91	46	5
206	211a/2 dr.	110	100	50	5
226	211a/2a dr.	150	113	56	5
306	211a/3 dr.	220	125	64	5
326	211a/3a dr.	325	144	71	1
406	211a/4 dr.	500	163	82	1
506	211a/5 dr.	730	183	90	1
606	211a/6 dr.	1135	215	104	1
706	211a/7 dr.	2250	257	127	1
806	211a/8 dr.	4300	298	150	1

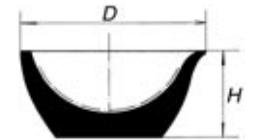

641 331 211 \*\*\*

<b>641 331 211 *** Miska trecia glazovaná Kat. č. 211b</b>					
***	Typ	V (ml)	D (mm)	H (mm)	Balenie (ks)
007	211a/0 gl.	25	60	32	10
107	211/1 gl.	30	70	37	10
117	211/1/0 gl.	50	81	42	5
127	211/1a gl.	75	91	46	5
207	211a/2 gl.	110	100	50	5
227	211a/2a gl.	150	113	56	5
307	211a/3 gl.	220	125	64	5
327	211a/3a gl.	325	144	71	1
407	211a/4 gl.	500	163	82	1
507	211a/5 gl.	730	183	90	1
607	211a/6 gl.	1135	215	104	1
707	211a/7 gl.	2250	257	127	1
807	211a/8 gl.	4300	298	150	1

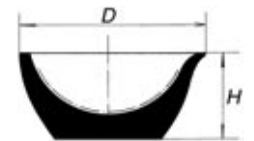

641 331 211 \*\*\*

<b>641 322 203 *** Miska žihacia hlboká, bez výlevky Kat. č. 203</b>					
***	Typ	V (ml)	D (mm)	H (mm)	Balenie (ks)
107	203/1	8	31	17	10
207	203/2	21	42	23	10
307	203/3	35	52	27	10
407	203/4	64	61	31	10
507	203/5	103	72	37	10

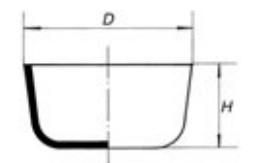

641 322 203 \*\*\*

<b>641 322 204 *** Miska žihacia nízka, bez výlevky Kat. č. 204</b>					
***	Typ	V (ml)	D (mm)	H (mm)	Balenie (ks)
207	204/2	7	38	10	10
307	204/3	9	44	11	10
407	204/4	12	47	13	10
607	204/6	70	81	20	10
807	204/8	220	122	28	10

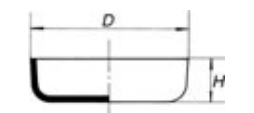

641 322 204 \*\*\*

<b>641 322 208 *** Miska žihacia nízka s výlevkou Kat. č. 208</b>					
***	Typ	V (ml)	D (mm)	H (mm)	Balenie (ks)
107	208/1	20	60	14	20
207	208/2	28	70	15	20
307	208/3	55	80	20	10
407	208/4	110	100	25	10
507	208/5	250	130	30	10
607	208/6	450	160	40	10

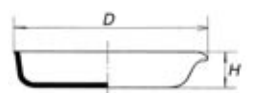

641 322 208 \*\*\*

## 1.2. Laboratórny porcelán

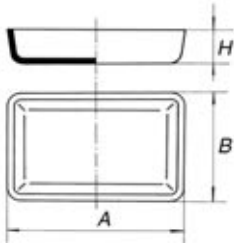

641 322 255 \*\*\*

<b>641 322 255 *** Miska žihacia štvorhranná</b>						<b>Kat. č. 255</b>
***	Typ	V (ml)	A (mm)	B (mm)	H (mm)	Balenie (ks)
107	255/1	6	50	35	12	10
207	255/2	13	62	40	12	10
227	225/2a	28	74	49	14	10
307	225/3	40	95	65	14	10

### Koronové žihacie a taviace kelímky

Obchodný názov materiálu: **AG 202**

Zloženie: 96% Al<sub>2</sub>O<sub>3</sub>

Technický názov: slinutá korundová keramika

Použitie: žihacie a taviace kelímky, odolné voči taveninám, pre použitie v laboratóriách a v priemysle až do teploty 1600 °C

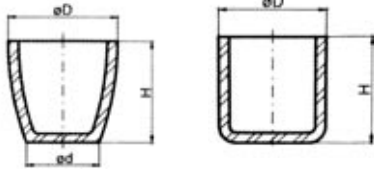

641 015 818 \*\*\*

641 015 818 \*\*\*

<b>641 015 818 *** Kelímok žihací a taviací</b>						
***	Typ	D(mm)	d(mm)	H (mm)	objem (mm)	Balenie (ks)
100	Kónický	35	25	45	27	1
200	Kónický	45	30	55	50	1
300	Kónický	60	35	70	120	1
400	Valcový	15	20	2,5	1	1
500	Valcový	28	38	14	1	1
600	Valcový	40	60	55	1	1

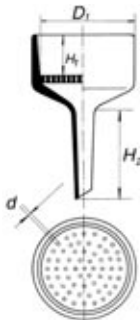

641 332 237 \*\*\*

<b>641 332 237 *** Lievik Büchnerov</b>						<b>Kat. č. 237</b>
***	Typ	D1 (mm)	d (mm)	H1 (mm)	H2 (mm)	Balenie (ks)
107	237/1	48	1	24	43	10
207	237/2	62	1	30	64	10
307	237/3	77	1	35	64	8
407	237/4	97	1,5	40	71	6
507	237/5	116	1,5	49	83	1
607	237/6	130	2	52	85	1
707	237/7	156	2	59	96	1
807	237/8	192	2	74	117	1
907	237/9	248	2	90	117	1
997	237/10	334	2	120	133	1

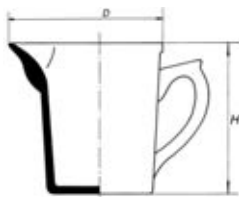

641 332 241 \*\*\*

<b>641 332 241 *** Odmerka s vnútornou graduáciou</b>					<b>Kat. č. 241</b>
***	Typ	V (ml)	D (mm)	H (mm)	Balenie (ks)
107	241/1	100	71	72	10
207	241/2	250	82	96	4
307	241/3	500	97	131	3
407	241/4	1000	127	160	1

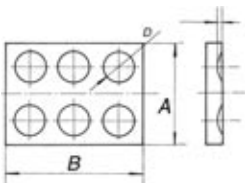

641 333 263 \*\*\*

<b>641 333 263 *** Platňa s jamkami</b>						<b>Kat. č. 263</b>
***	Typ	A(mm)	B (mm)	D (mm)	Počet jamiek	Balenie (ks)
507	263/5	81	112	25	6	10
607	263/6	91	115	17	12	10

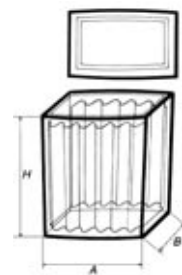

641 332 372 \*\*\*

<b>641 332 372 *** Skrinka farbiarska s viečkom</b>					<b>Kat. č. 372</b>
***	Typ	A (mm)	B (mm)	H (mm)	Balenie (ks)
001	372	70	40	86	1

<b>641 331 213 *** Tíčk trecí drsný</b>				<b>Kat. č. 213a</b>
***	Typ	D (mm)	L (mm)	Balenie (ks)
006	213/0 dr.	15	52	10
106	213/1 dr.	23	84	10
206	213/2 dr.	26	103	5
306	213/3 dr.	37	132	5
406	213/4 dr.	44	158	1
506	213/5 dr.	58	210	1
606	213/6 dr.	73	255	1
706	213/7 dr.	86	305	1
806	213/8 dr.	103	370	1



641 331 213 006

<b>641 331 213 *** Tíčk trecí glazovaný</b>				<b>Kat. č. 213b</b>
***	Typ	D (mm)	L (mm)	Balenie (ks)
007	213/0 gl.	15	52	10
107	213/1 gl.	23	84	10
207	213/2 gl.	26	103	5
307	213/3 gl.	37	132	5
407	213/4 gl.	44	158	1
507	213/5 gl.	58	210	1
607	213/6 gl.	73	255	1
707	213/7 gl.	86	305	1
807	213/8 gl.	103	370	1